

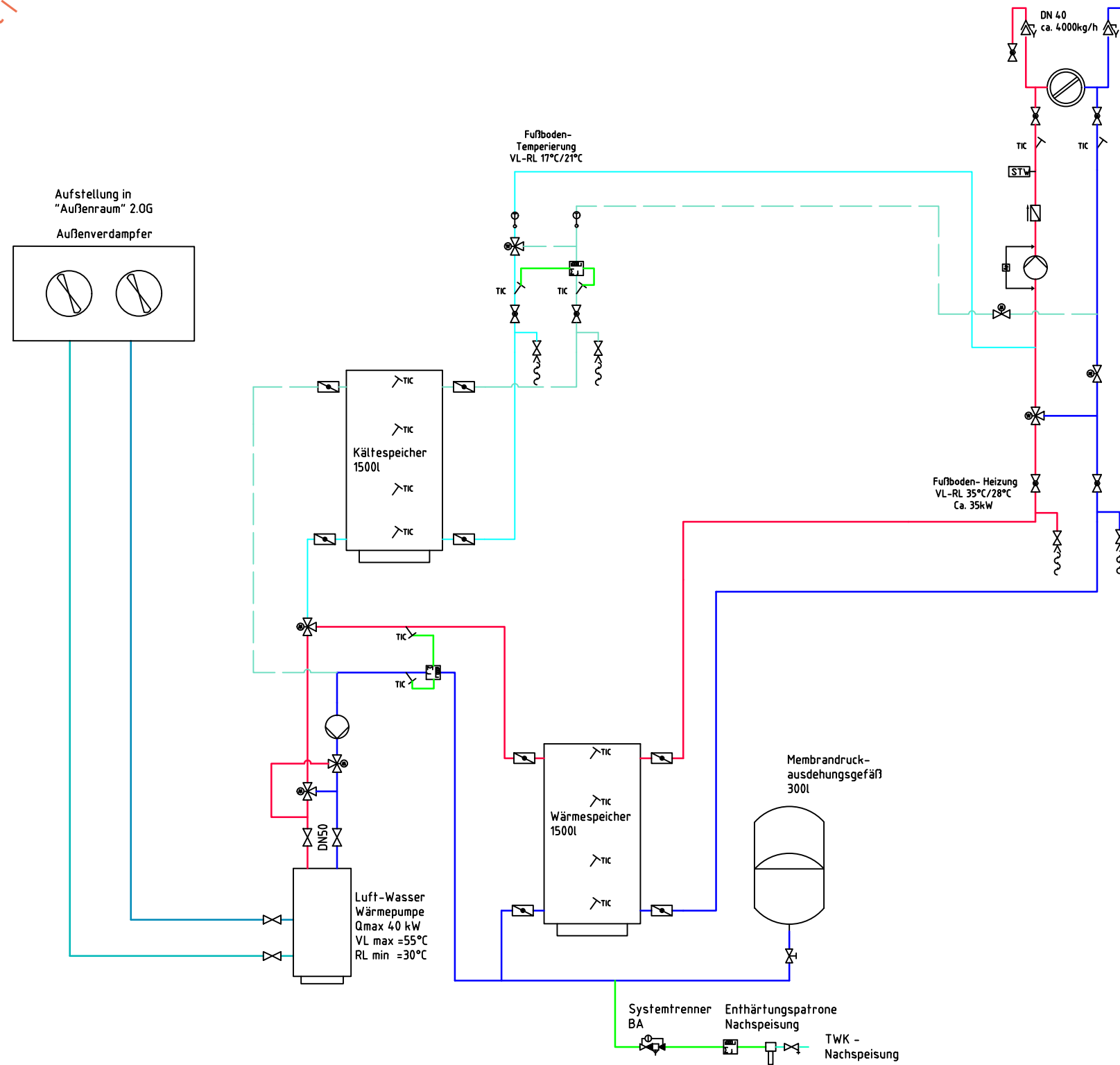













# LERNHAUS 2



## LEGENDE

RLT Zuluft	
RLT Abluft	
RLT Fortluft	
RLT Aussenluft	
Heizung Vorlauf	
Heizung Rücklauf	
Fußbodenheizung	
Kühlung Vorlauf	
Kühlung Rücklauf	
Sanitär Trinkwasser kalt	
Sanitär Trinkwasser warm	
Sanitär Trinkwasser Zirkulation	
Sanitär Schmutzwasser	
Sanitär Regenwasser	

## INHALT

SCHULBAU OPEN SOURCE  
 Projektphase: Vorplanung  
 Ingenieurbüro Hausladen GmbH

Lernhaus 2  
 Funktionsschema  
 HEIZUNG – HYDRAULIK